

Name	<i>Voldemort 120x204_16</i>		
Zeichnung/Drawing	<i>3D</i>		
Profil/Profile	<i>1.6x8.9</i>	Datum/Date	<i>24.11.2022</i>

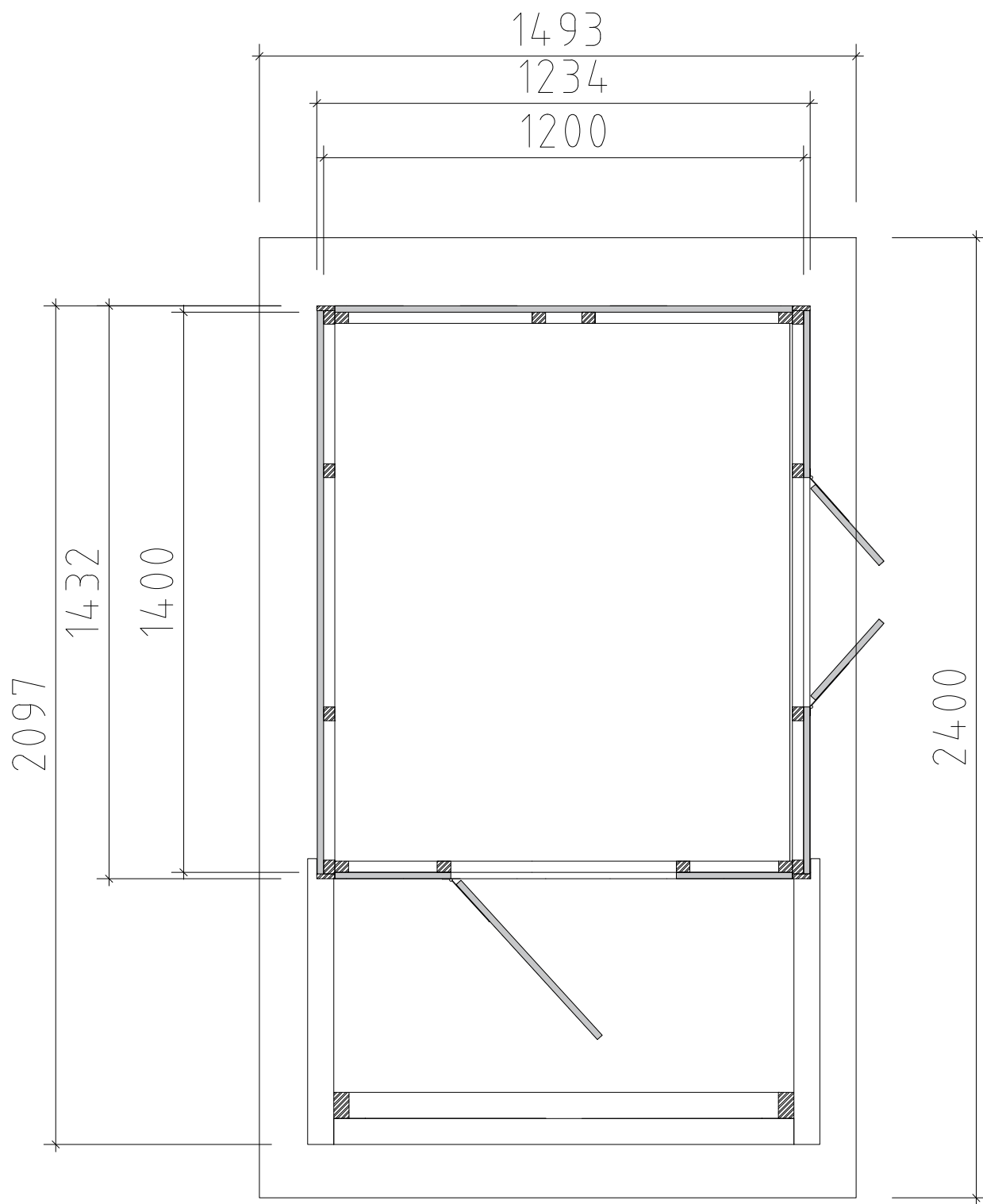

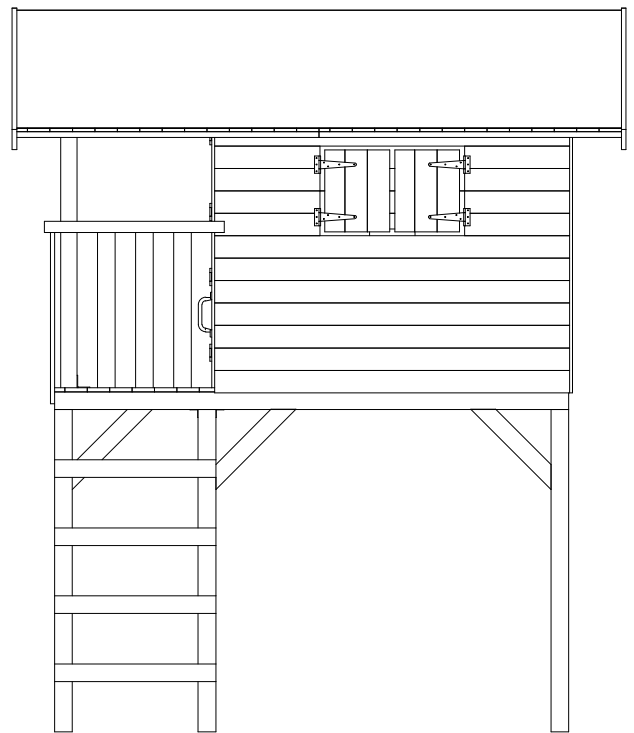

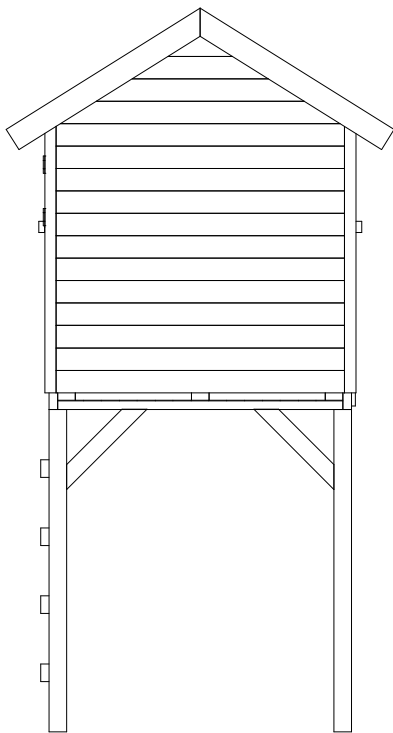

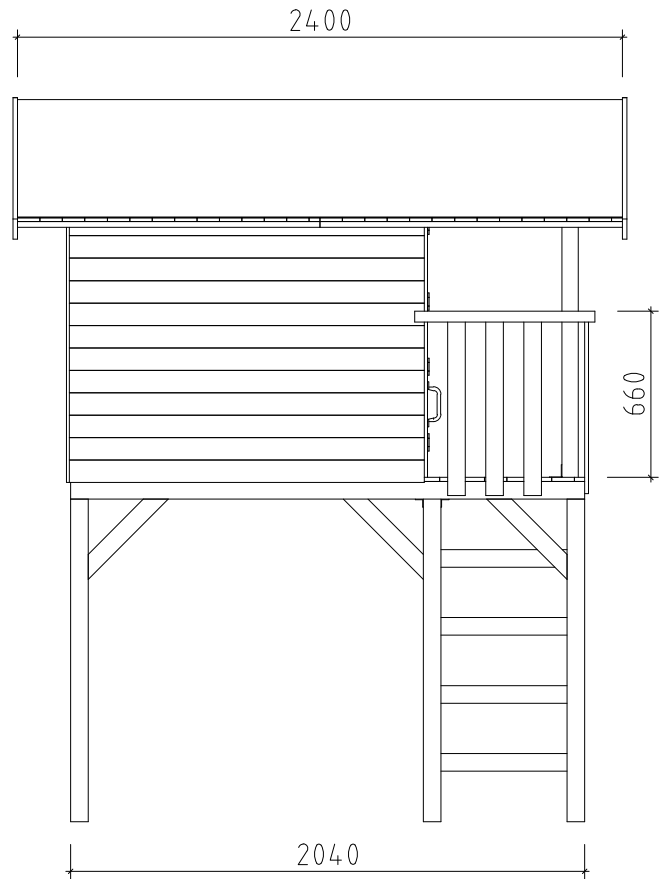
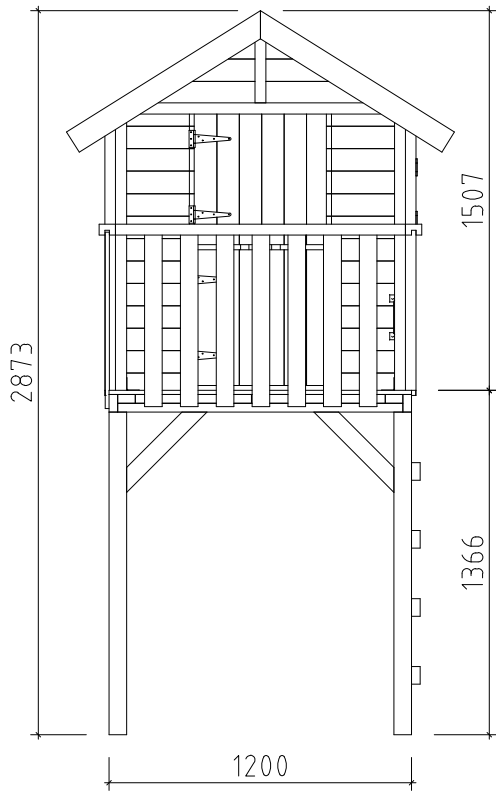

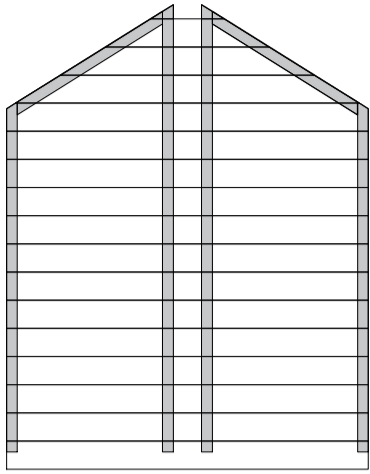
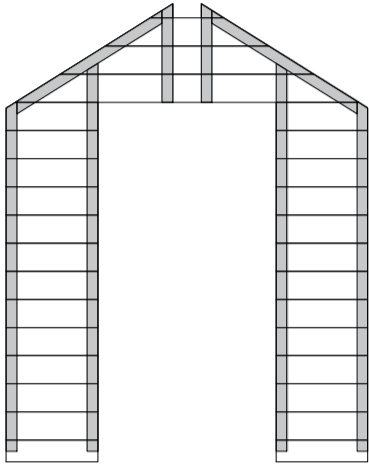
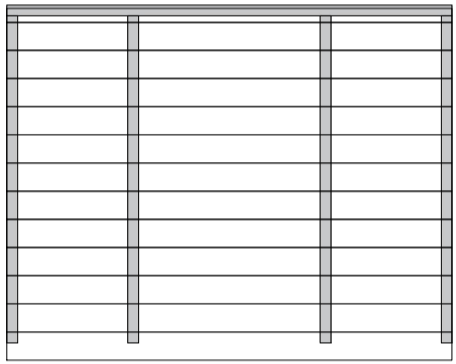
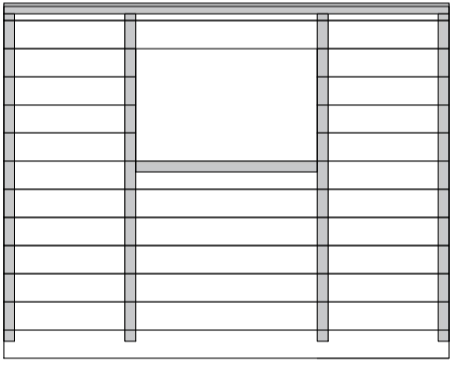
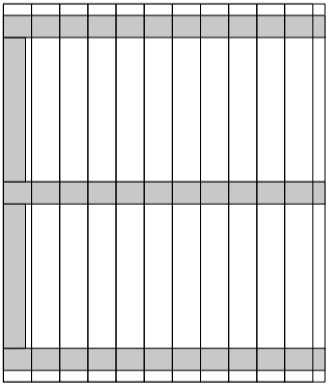
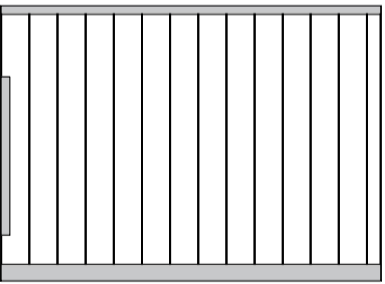
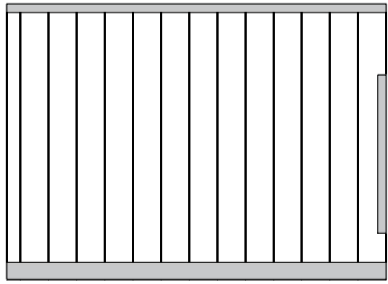
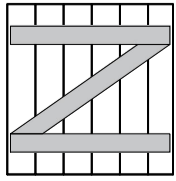

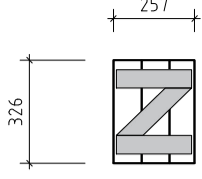
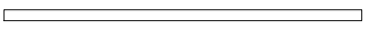

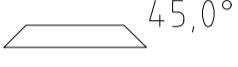



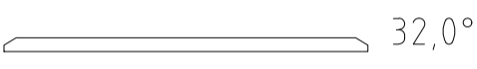



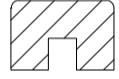
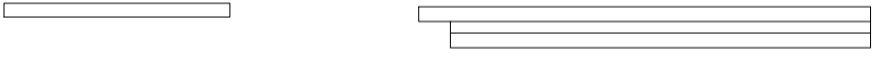

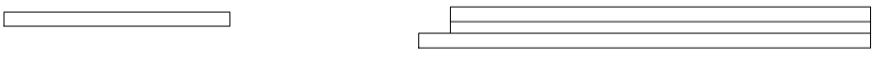
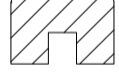
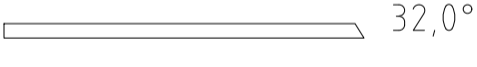
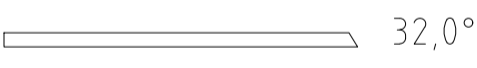



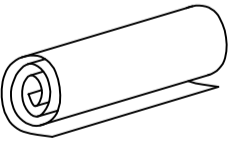
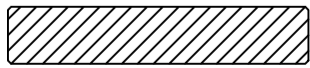
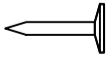
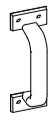
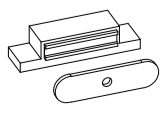

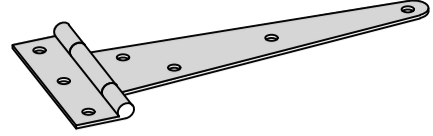

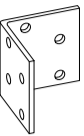
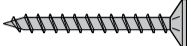











Name	Voldemort 120x204_16		
Zeichnung/ Drawing	PLAN/PLAN	Kunde/ Client	
Profil/ Profile	1.6x8.9	Datum/ Date	24.11.2022



Name	<i>Voldemort 120x204_16</i>		
Zeichnung/ Drawing	<i>WAND/WALL</i>	Kunde/ Client	
Profil/ Profile	<i>1.6x8.9</i>	Datum/ Date	<i>24.11.2022</i>

Pos	Teieliste/Specification Voldemort 120x204_16	Stck Pcs.	Profil Profile (mm)	Länge Length (mm)
EL1		1	1144x1469	
EL2		1	1144x1469	
EL3		1	1408x1123	
EL4		1	1408x1123	
FL		2	1018x1195	
RF1		2	1200x870	
RF2		2	1200x870	
DR		2	524x539	

Pos	Teileliste/Specification Voldemort 120x204_16		Stck Pcs.	Profil Profile (mm)	Länge Length (mm)	
	WD		2	257x326		
LT1		LATTEN - STUDS 	3	70x34	1132	
LT11		LATTEN - STUDS 	2	34x70	2040	
STF1		STÜTZPFOSTE - SUPPORT POST 	5	70x70	1280	
STF2	45,0°	STÜTZPFOSTE - SUPPORT POST 	8	34x70	450	
LT19		LATTEN - STUDS 	1	34x28	1144	
LT20		LATTEN - STUDS 	2	34x28	290	
LT15		LATTEN - STUDS 	2	34x28	1408	
TB3	32,0°	TRÄGEBALKE - SUPPORT BEAM 	1	44x65	1151	
TB2		TRÄGEBALKE - SUPPORT BEAM 	1	44x65	266	
TB1		TRÄGEBALKE - SUPPORT BEAM 	2	44x65	1097	
LE1		LEISTE - LATH 		1	65x44	1151
LE5a		LEISTE - LATH 		1	65x44	715
LE5b		LEISTE - LATH 		1	65x44	715
LE2		LEISTE - LATH 	✓	2	45x12	1139
LE3		LEISTE - LATH 	✓	2	45x12	1119
LE4		LEISTE - LATH 		2	27x27	180
RDL1		LEITER - LADDER 	4	70x34	640	
GL1		GELÄNDER - HANDRAIL 	10	70x16	700	
KP-1	DACHPAPPE - ROOFING FELT		✓		3.0m-2st	
G01-1	GIEBELBRETTER - GABLE BOARDS 18x95	32,0° 	✓	4	18x95	910
NG01	DACHPAPPNÄGEL - ROOFING NAILS 2.8x15		36			
GV-KP	Handle - Handgriff		1			
MG01	MAGNET - MAGNET		4			

Pos	Teileliste/Specification Voldemort 120x204__16		Stck Pcs.	Profil Profile (mm)	Länge Length (mm)
H02	T-SCHARNIER - T-HINGE 150mm KZN		8		
W08	Winkel - Angle bracket 30x30x25		2		
W01	Winkel - Angle bracket 40x40x40		4		
SR3 032	Schrauben - Screws 3.0x30 C3 Magnet - Magnet		8		
SR3 018	Schrauben - Screws 3.0x16 C3 Magnet - Magnet		4		
SR3 542	Schrauben - Screws 3.5x40 C3 Winkel - Angle bracket		40		
SR3 542	Schrauben - Screws 3.5x40 C3 LE4		4		
SR3 542	Schrauben - Screws 3.5x40 C3 LE2, LE3		12		
SR3 542	Schrauben - Screws 3.5x40 C3 RF1+RF2		8		
SR3 542	Schrauben - Screws 3.5x40 C3 Giebelbretter - Gable board		12		
SR4 032	Schrauben - Screws 4.0x30 C3 T-Scharnier - T-Hinge		48		
SR4 062	Schrauben - Screws 4.0x60 C3 FL		16		
SR4 062	Schrauben - Screws 4.0x60 C3 LT15, LT19, LT20		16		
SR4 062	Schrauben - Screws 4.0x60 C3 Montage der Wandelemente / Assembly of wall elements		32		
SR4 062	Schrauben - Screws 4.0x60 C3 Geländer - Handrail GL1		40		
SR4 062	Schrauben - Screws 4.0x60 C3 LE5		4		
SR4 572	Schrauben - Screws 4.5x70 C3 LT1, LT11		12		
SR4 572	Schrauben - Screws 4.5x70 C3 Leiter - Ladder RDL1		16		
SR4 572	Schrauben - Screws 4.5x70 C3 STF2		16		
SR4 572	Schrauben - Screws 4.5x70 C3 RF		14		
SR5 0102	Schrauben - Screws 5.0x100 C3 Stützpfole - Support post		8		
SR5 0102	Schrauben - Screws 5.0x100 C3 STF2		16		
SR5 0102	Schrauben - Screws 5.0x100 C3 Trägebalken - Support beam		6		
SR5 0102	Schrauben - Screws 5.0x100 C3 LE1, LE5		8		
SR5 032	Schrauben - Screws 5.0x30 C3 Handle - Handgriff		4		
	✓ - Bitte selber anpassen (falls nötig)! / Cut into length on site (if needed)!				

Aufbau Anleitung für/Installation guide for "Voldemort 120x204_16"

1. Rahmen / Frame

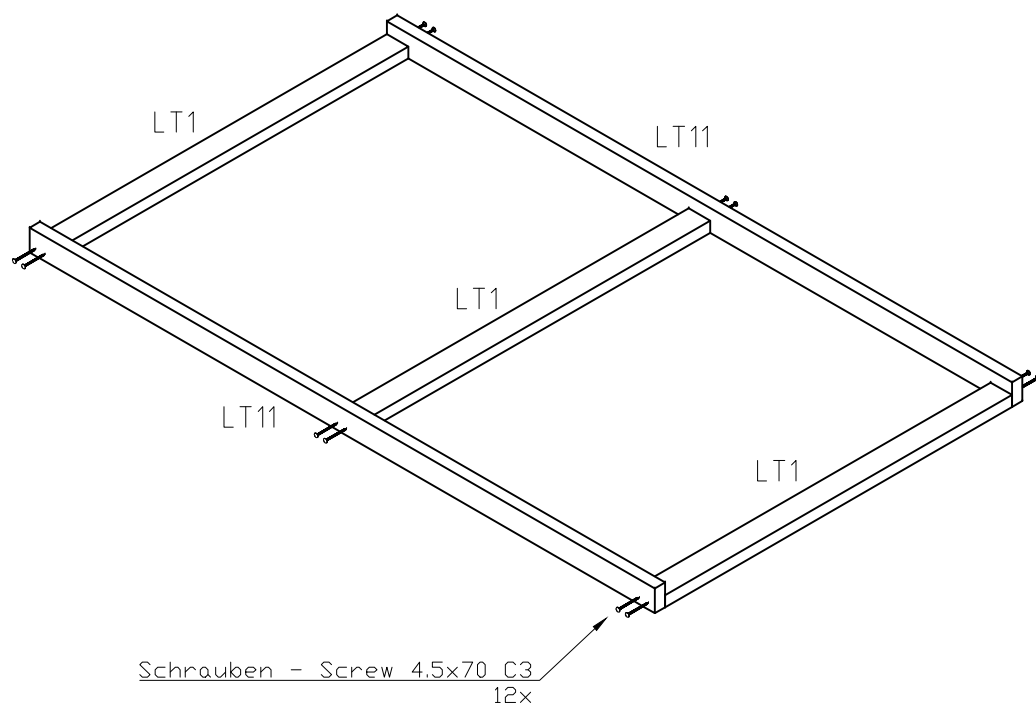

2. Leiter - Ladder

Schrauben - Screw 4.5x70 C3 16x

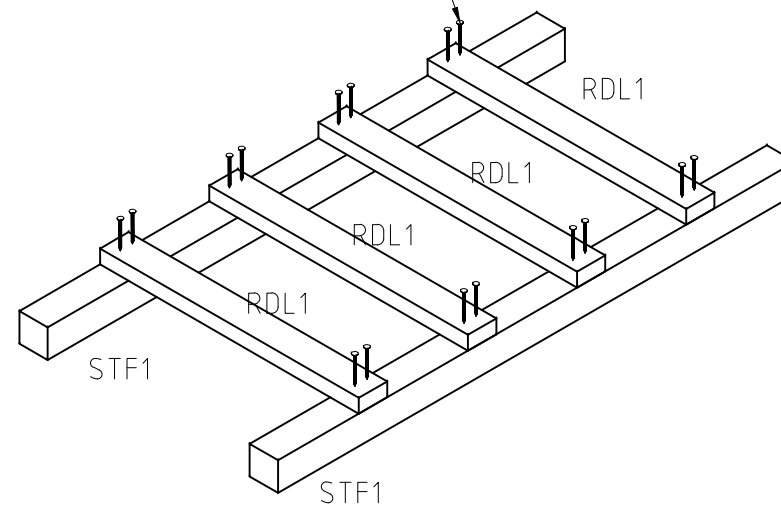

3. Stützpfeiler - Support posts

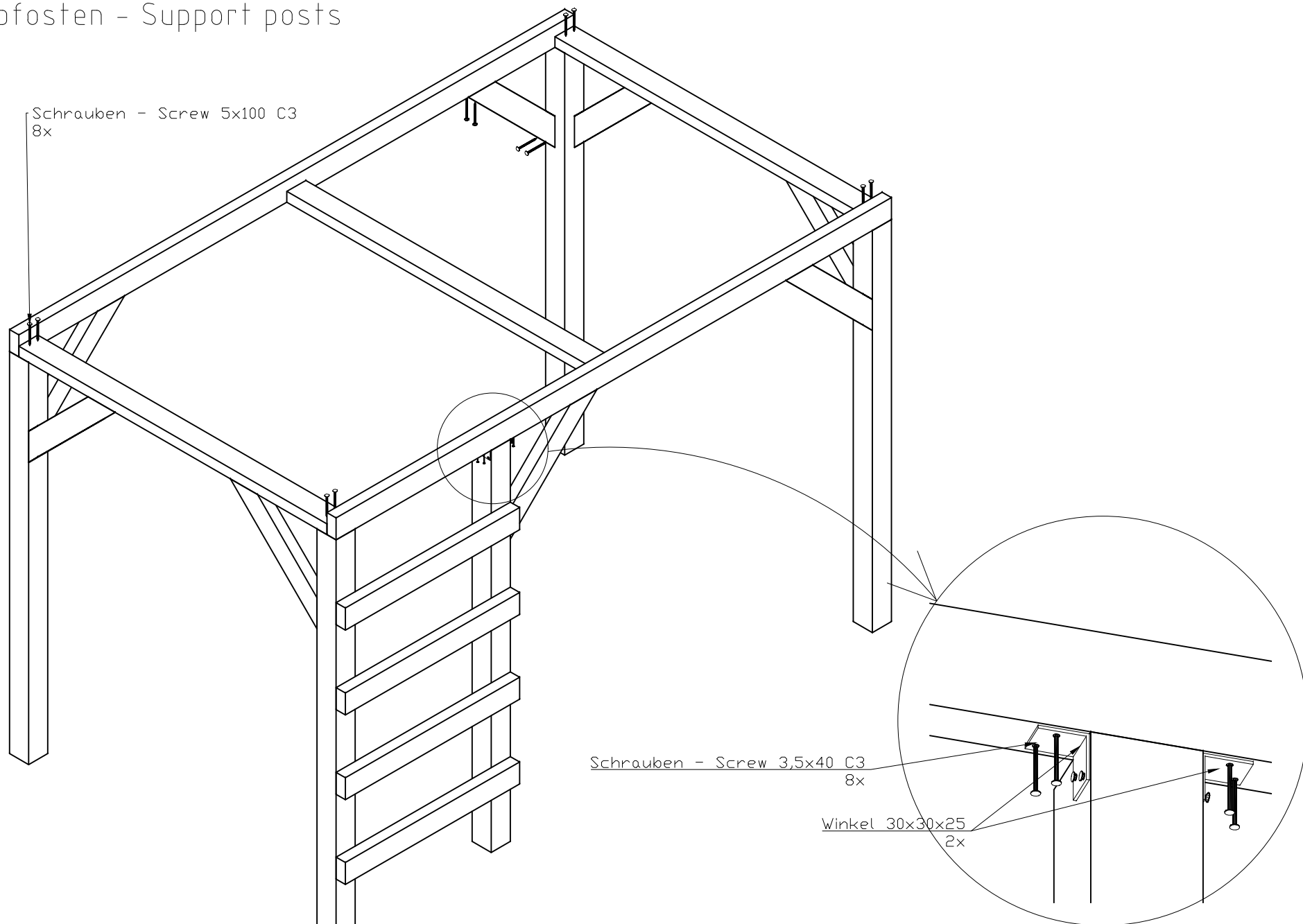

Aufbau Anleitung für/Installation guide for "Voldemort 120x204_16"

4. Fussboden / Floor boards

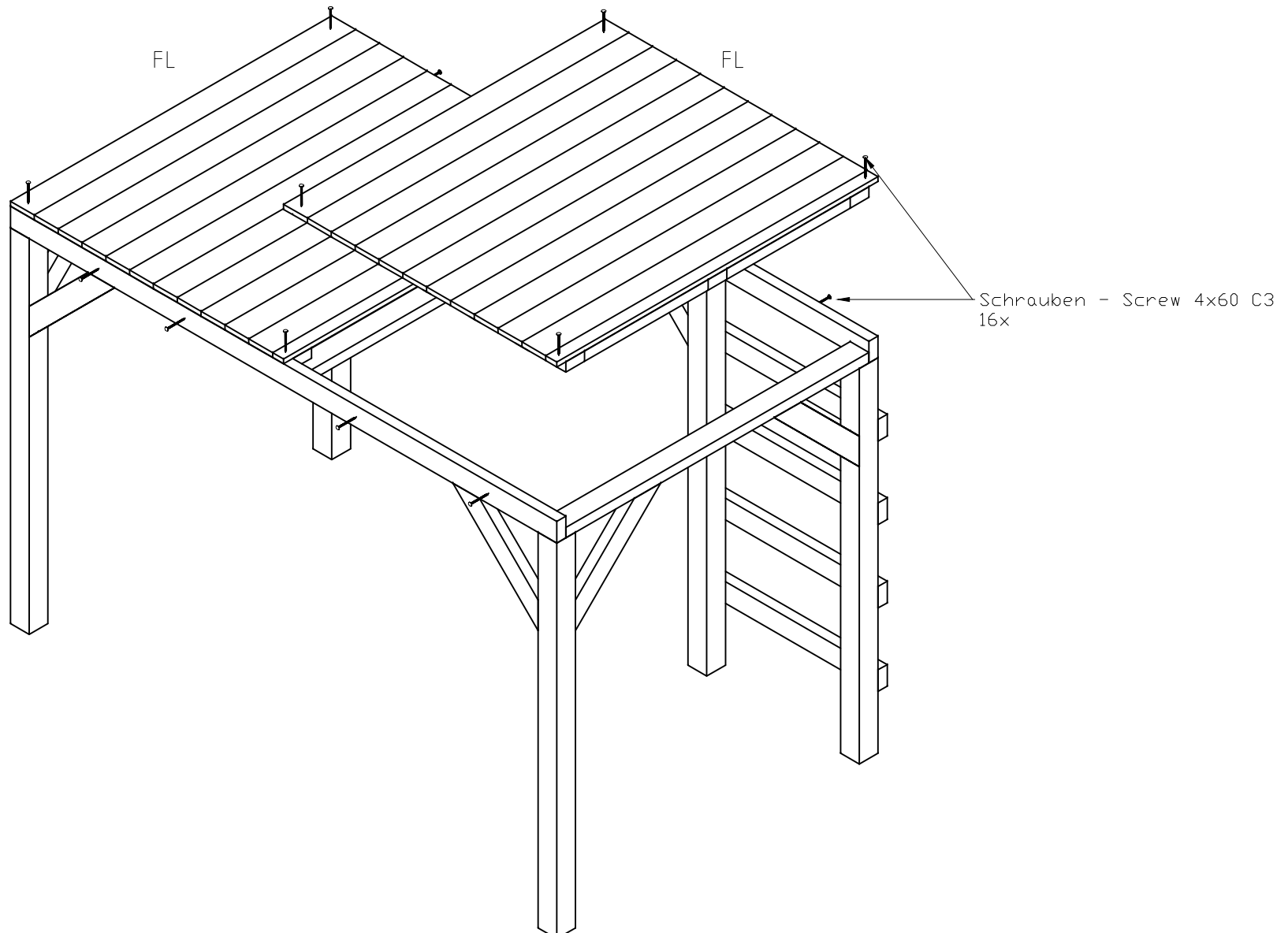

Aufbau Anleitung für/Installation guide for "Voldemort 120x204_16"

5.1 Montage der Wandelemente / Assembly of wall elements

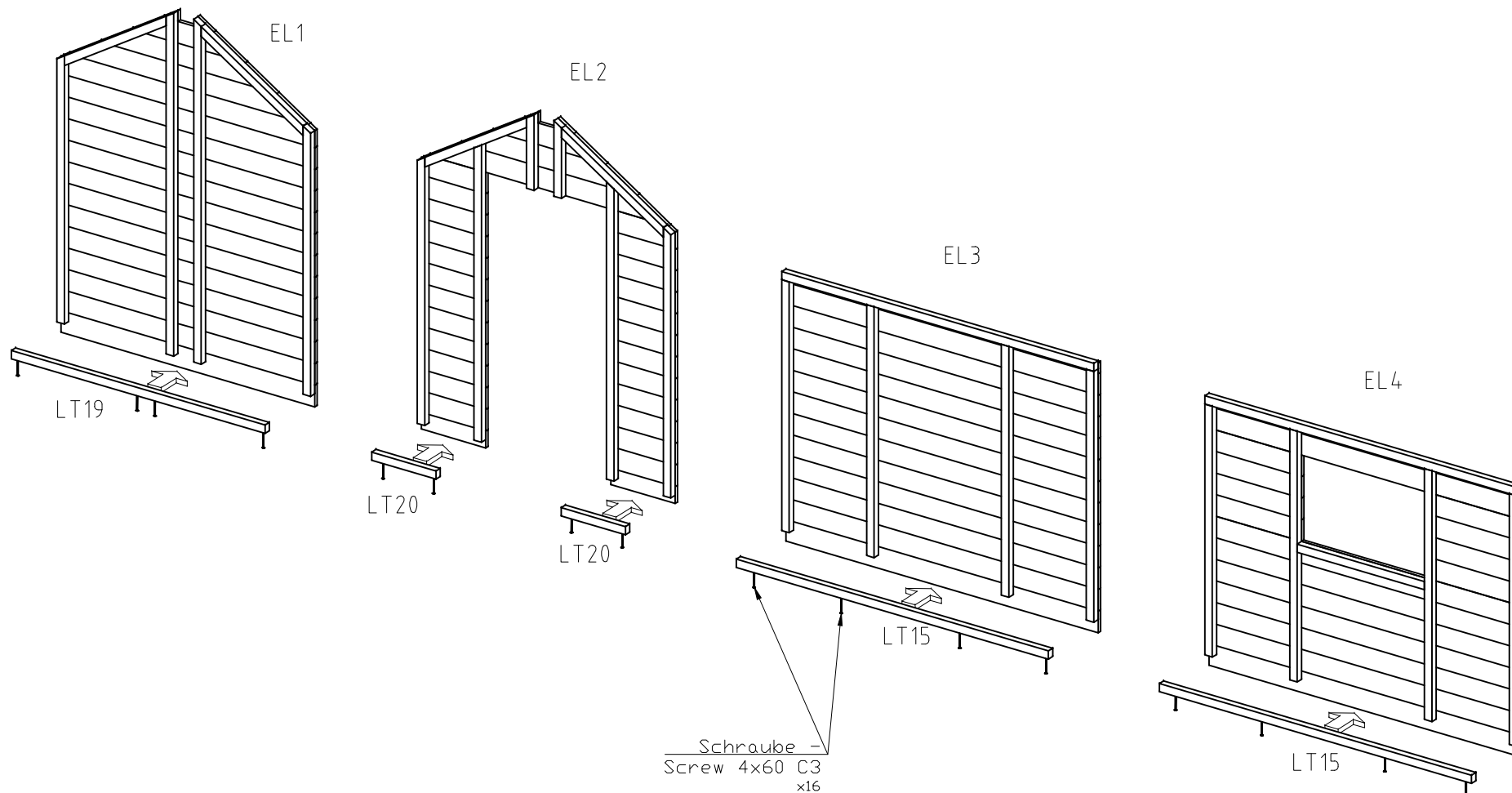

5.2 Montage der Wandelemente / Assembly of wall elements

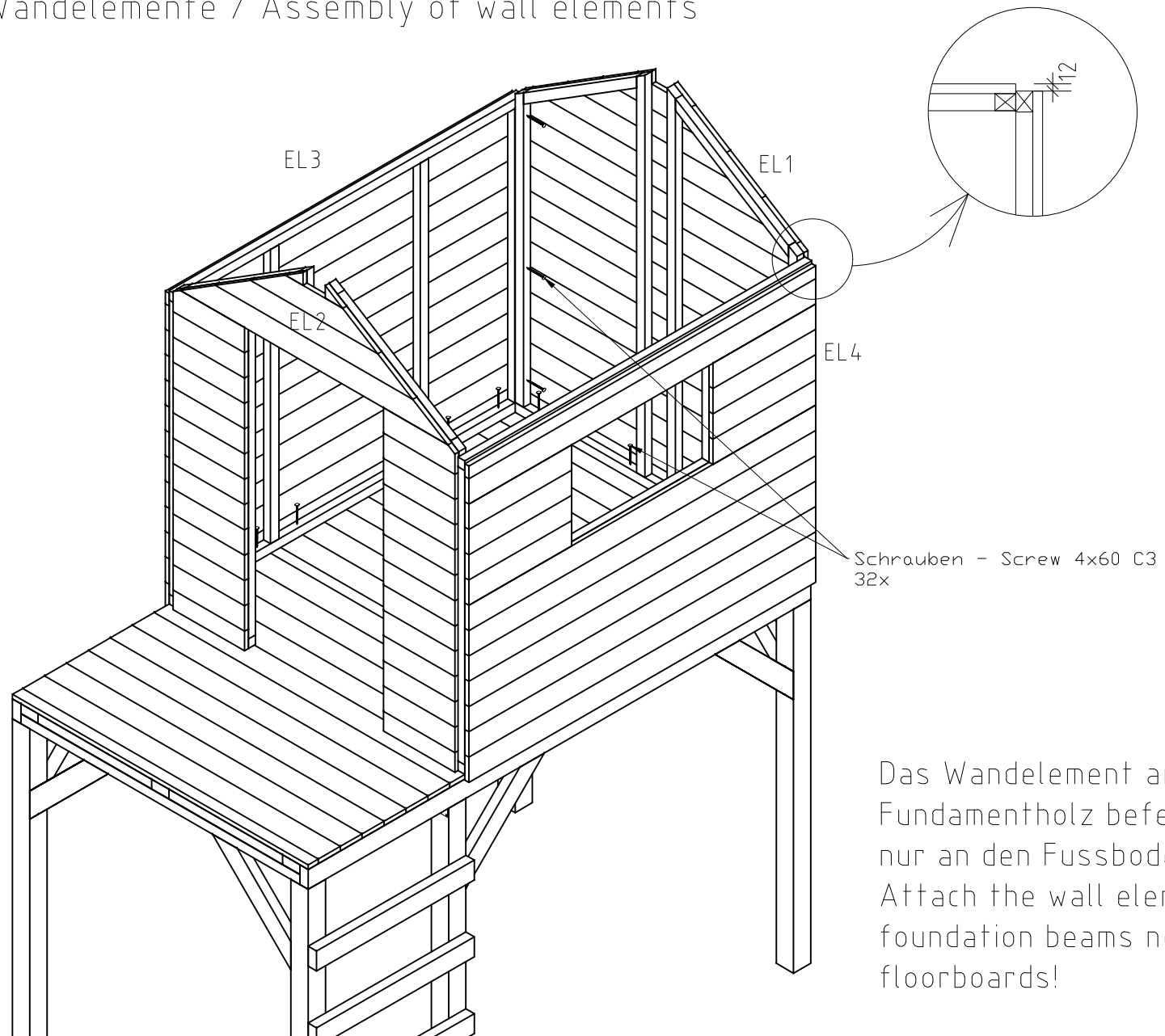

Aufbau Anleitung für/Installation guide for "Voldemort 120x204_16"

6.1 Magnet / Magenet

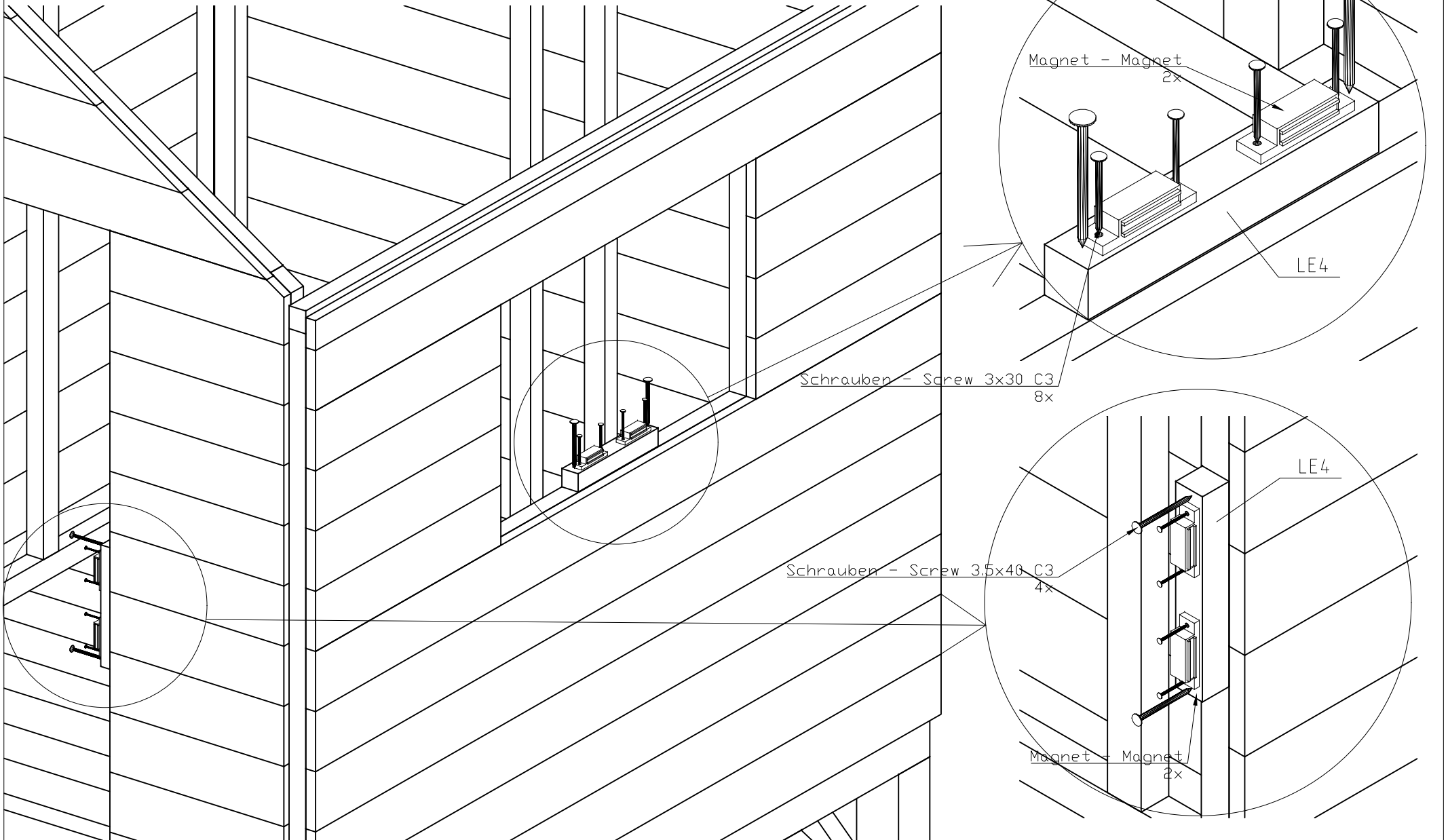

Aufbau Anleitung für/Installation guide for "Voldemort 120x204_16"

6.2 Magnet / Magenet

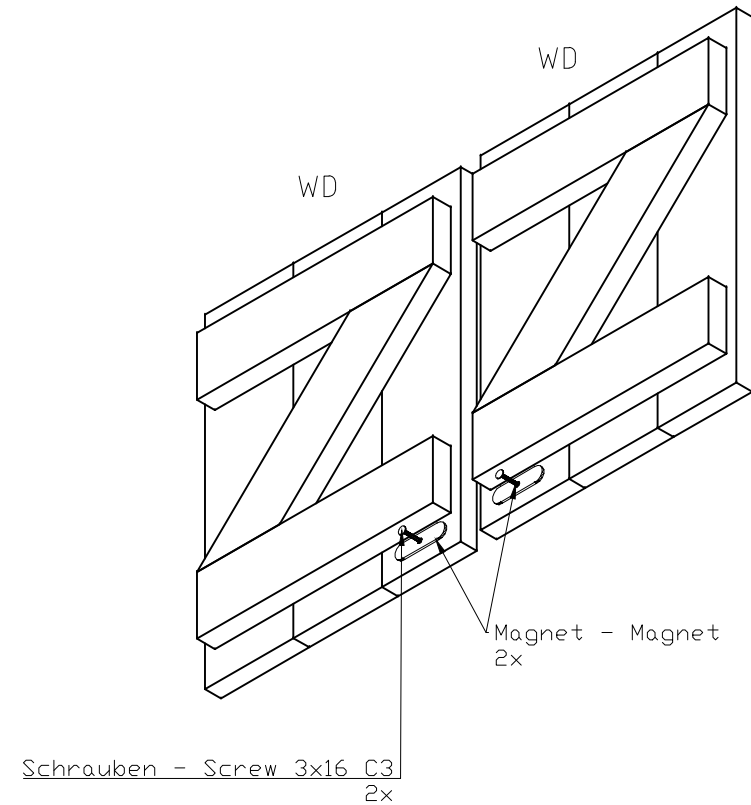
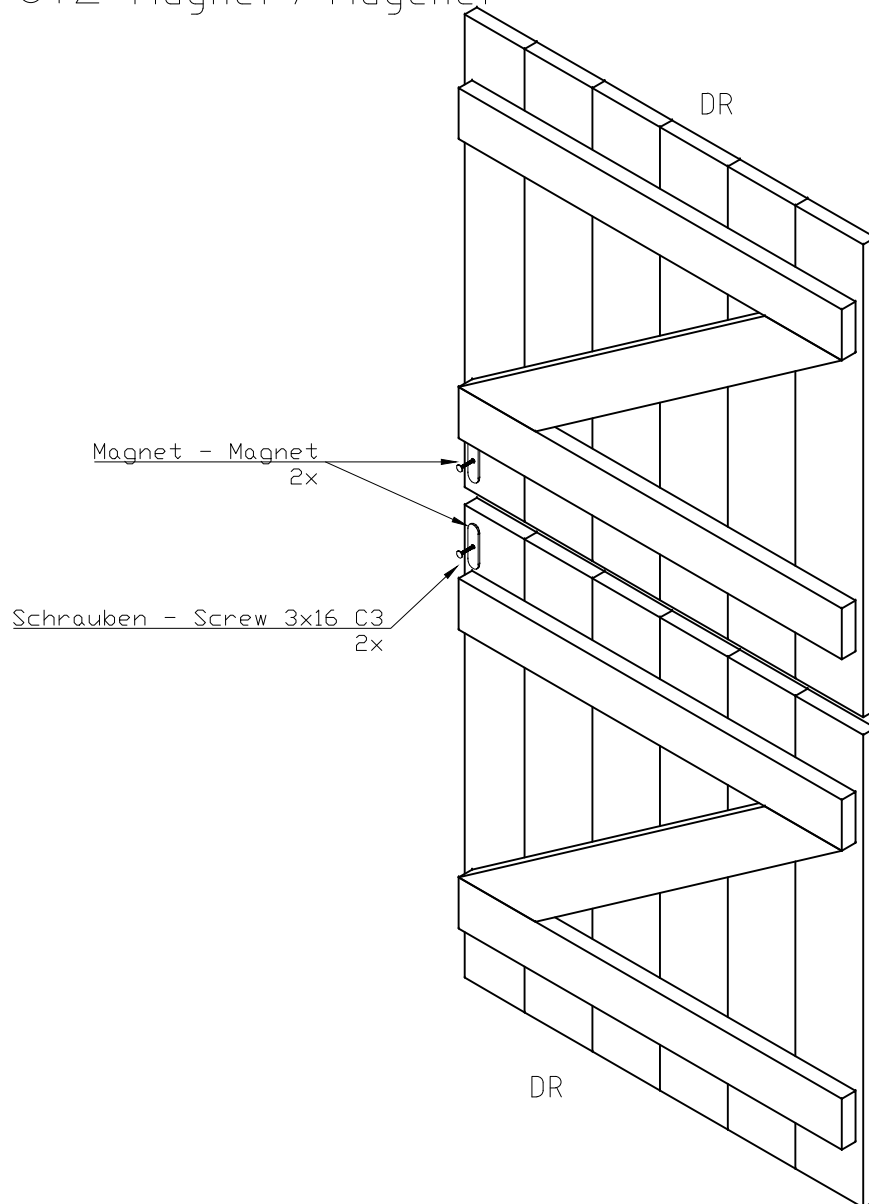

Aufbau Anleitung für/Installation guide for "Voldemort 120x204_16"

7. Tür / Door - Fenster / Window

Schrauben - Screw 4x30 C3
48x

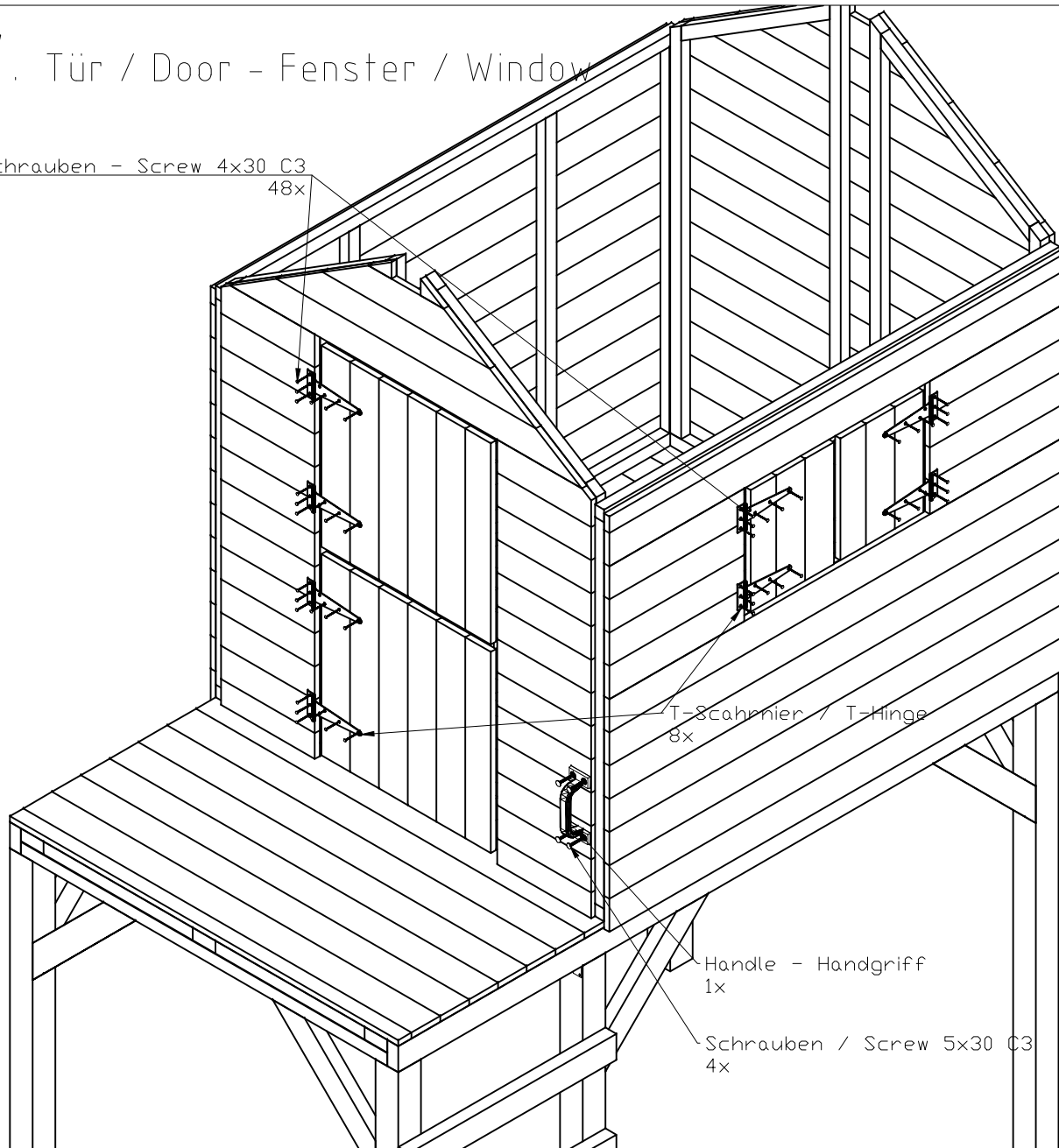

T-Scharnier / T-Hinge
8x

Handle - Handgriff
1x

Schrauben / Screw 5x30 C3
4x

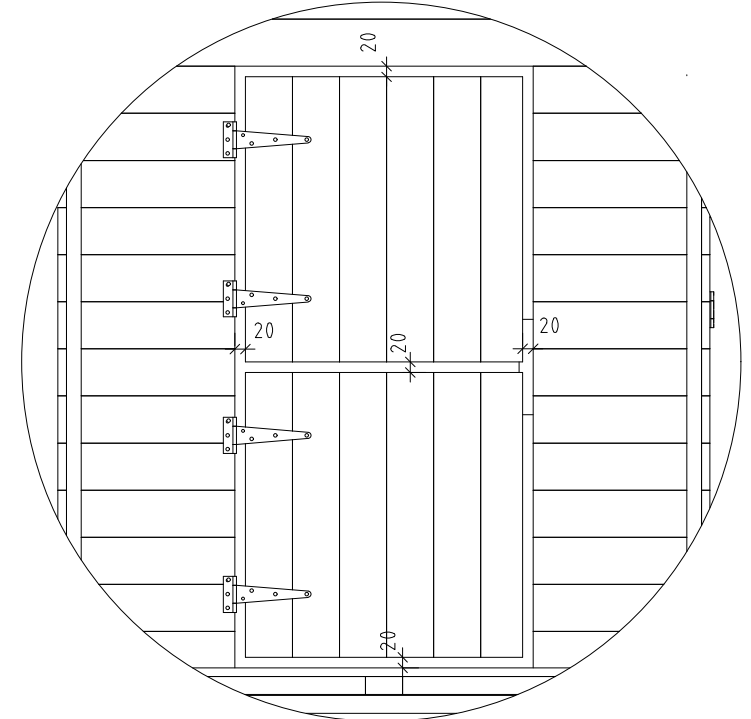
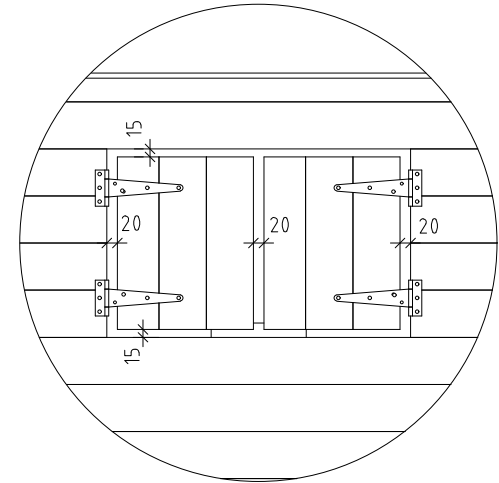

Aufbau Anleitung für/Installation guide for "Voldemort 120x204_16"

8. Leiste / Lath

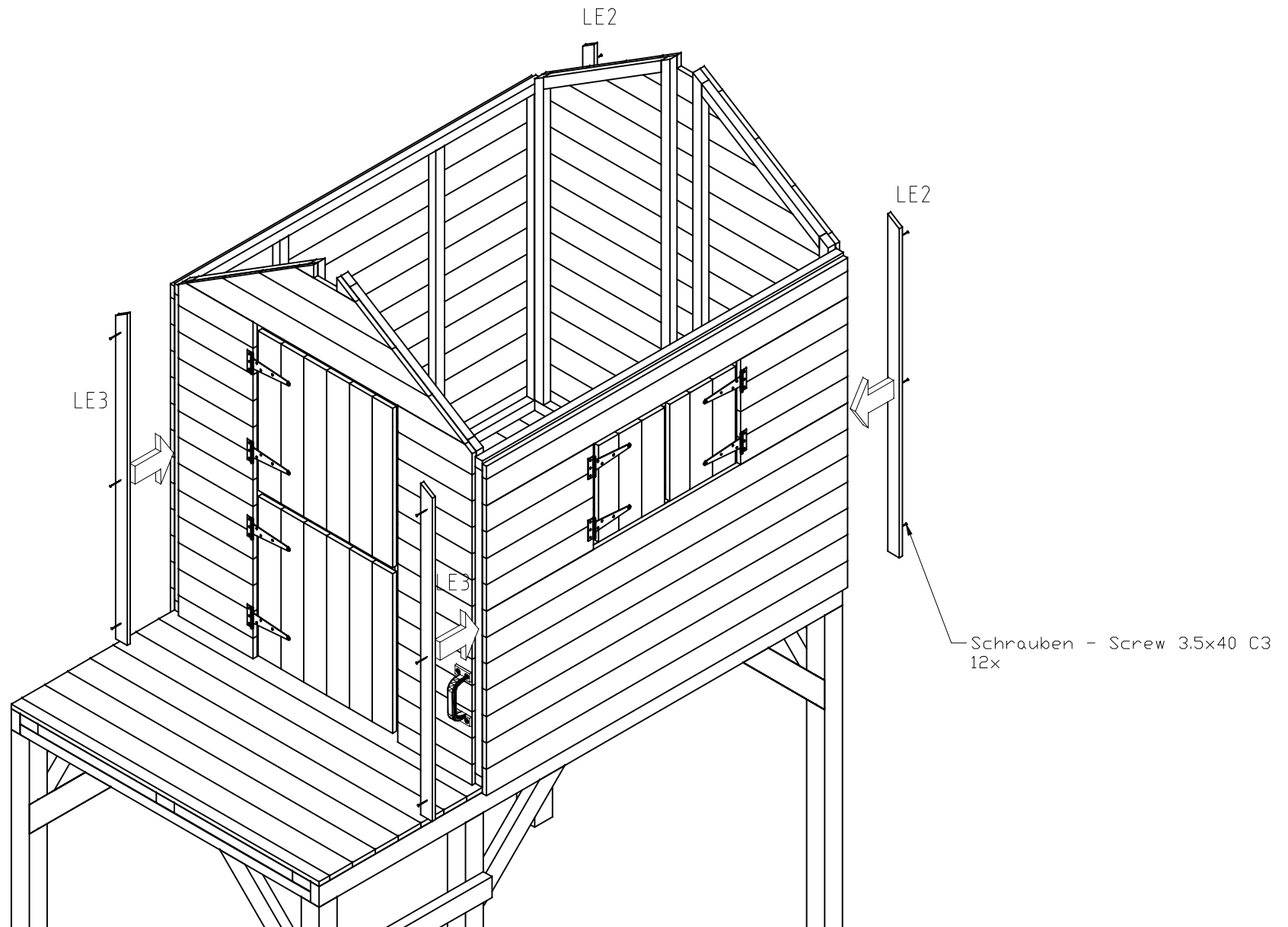

Aufbau Anleitung für/Installation guide for "Voldemort 120x204_16"

9. Trägebalken / Support beams

Schrauben - Screw 5x100 C3
6x

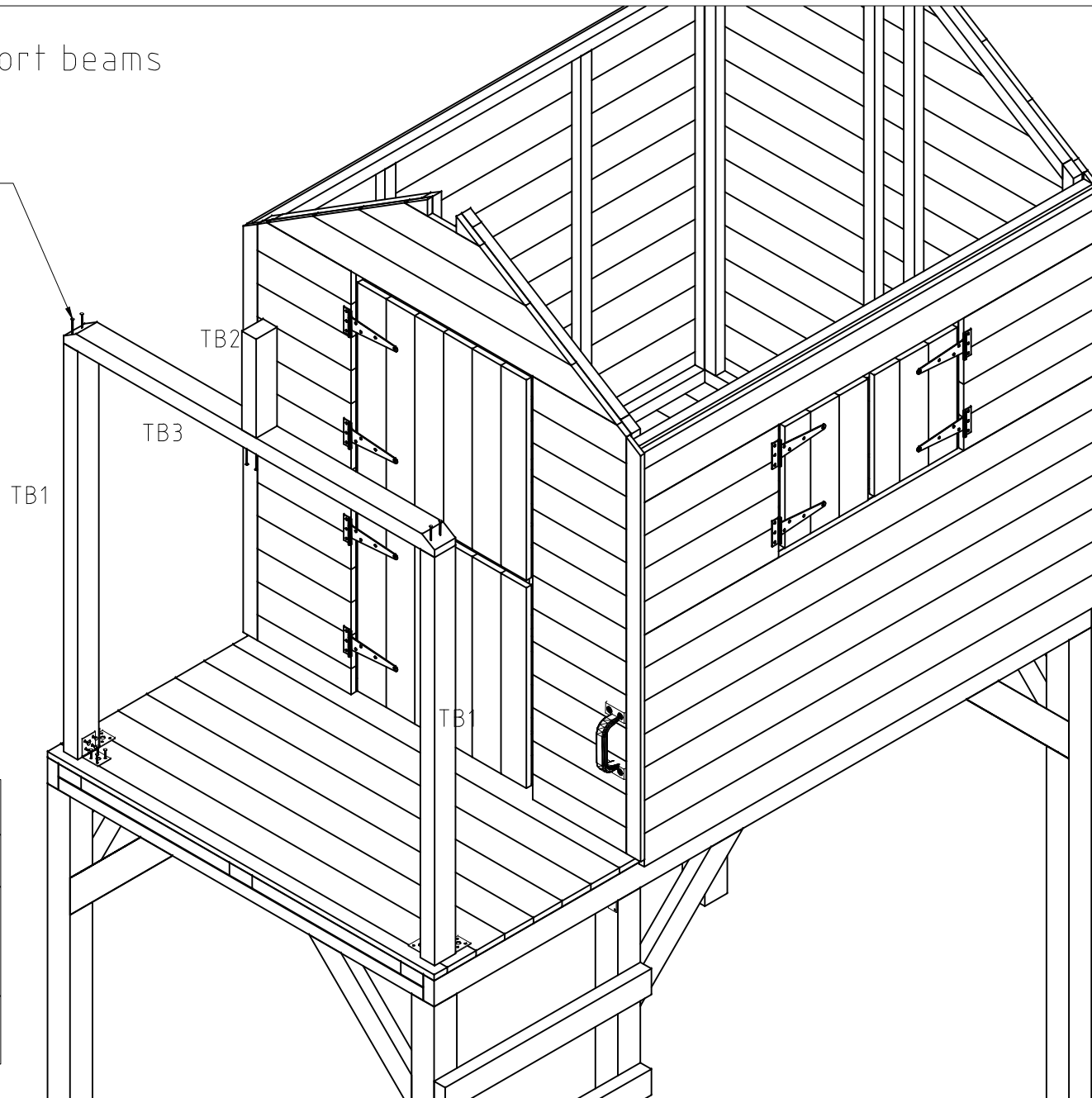

Winkel / Angle bracket 40x40x40
x4

Schrauben / Screw 3.5x40
x32

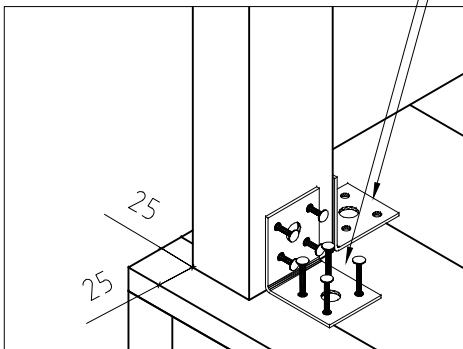

Aufbau Anleitung für/Installation guide for "Voldemort 120x204_16"

10.1 Geländer / Handrail

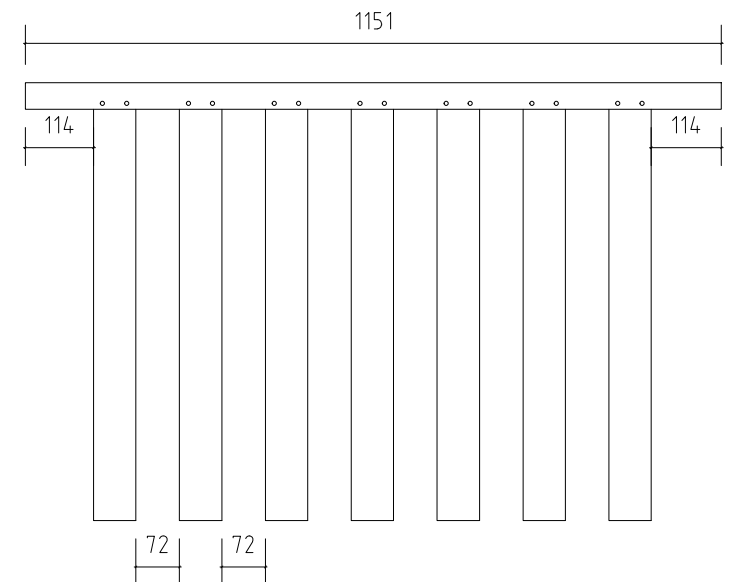
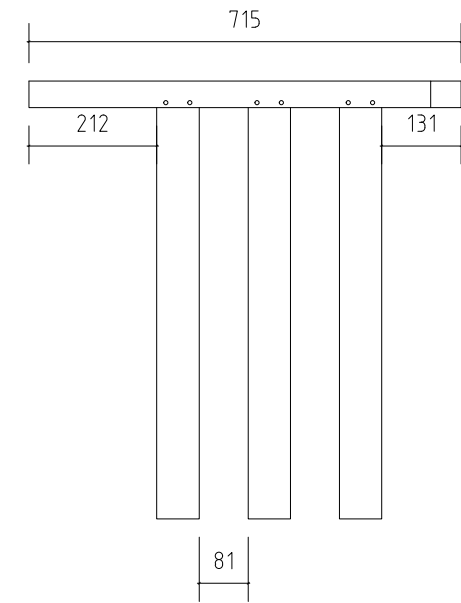
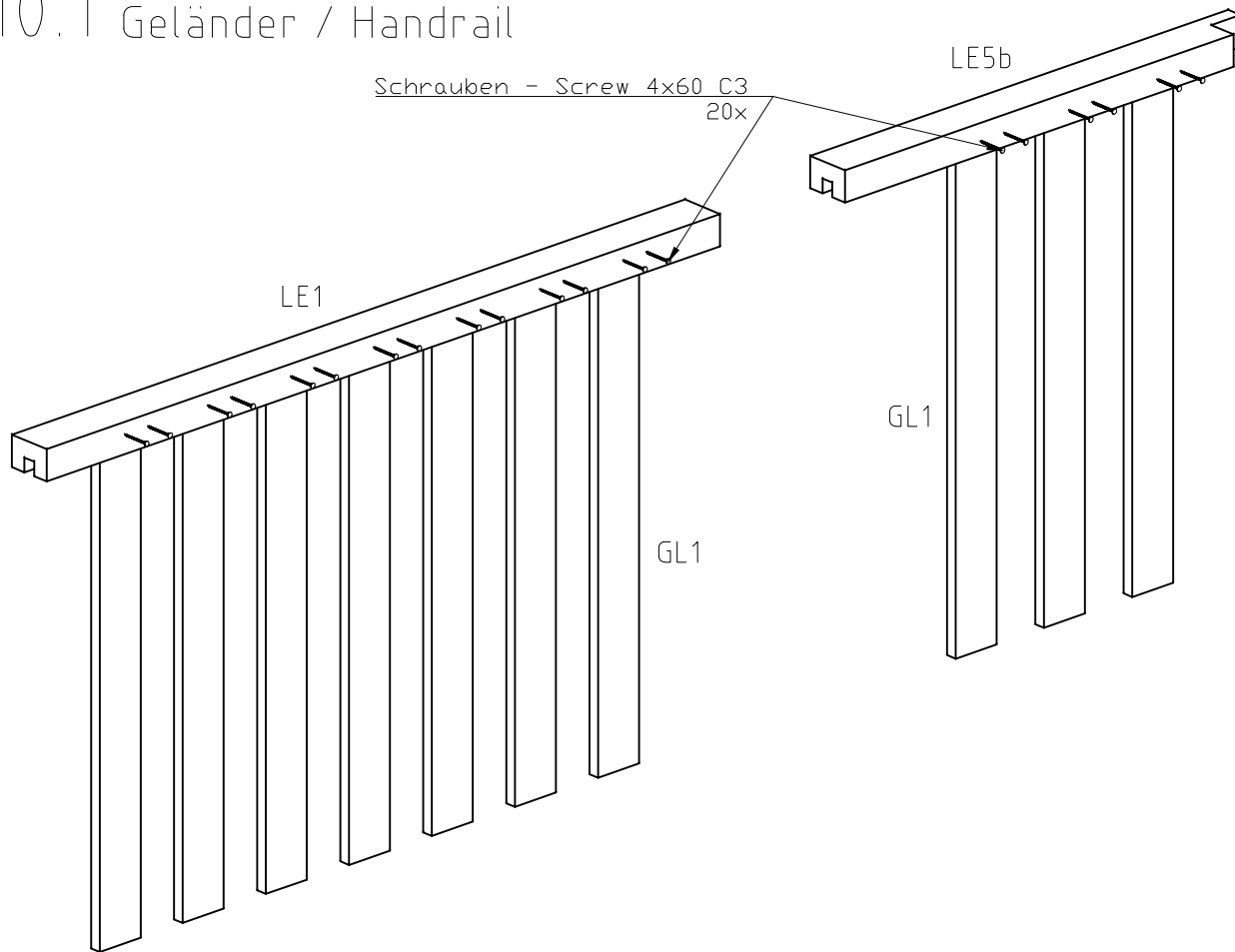

Aufbau Anleitung für/Installation guide for "Voldemort 120x204_16"

10.2 Geländer / Handrail

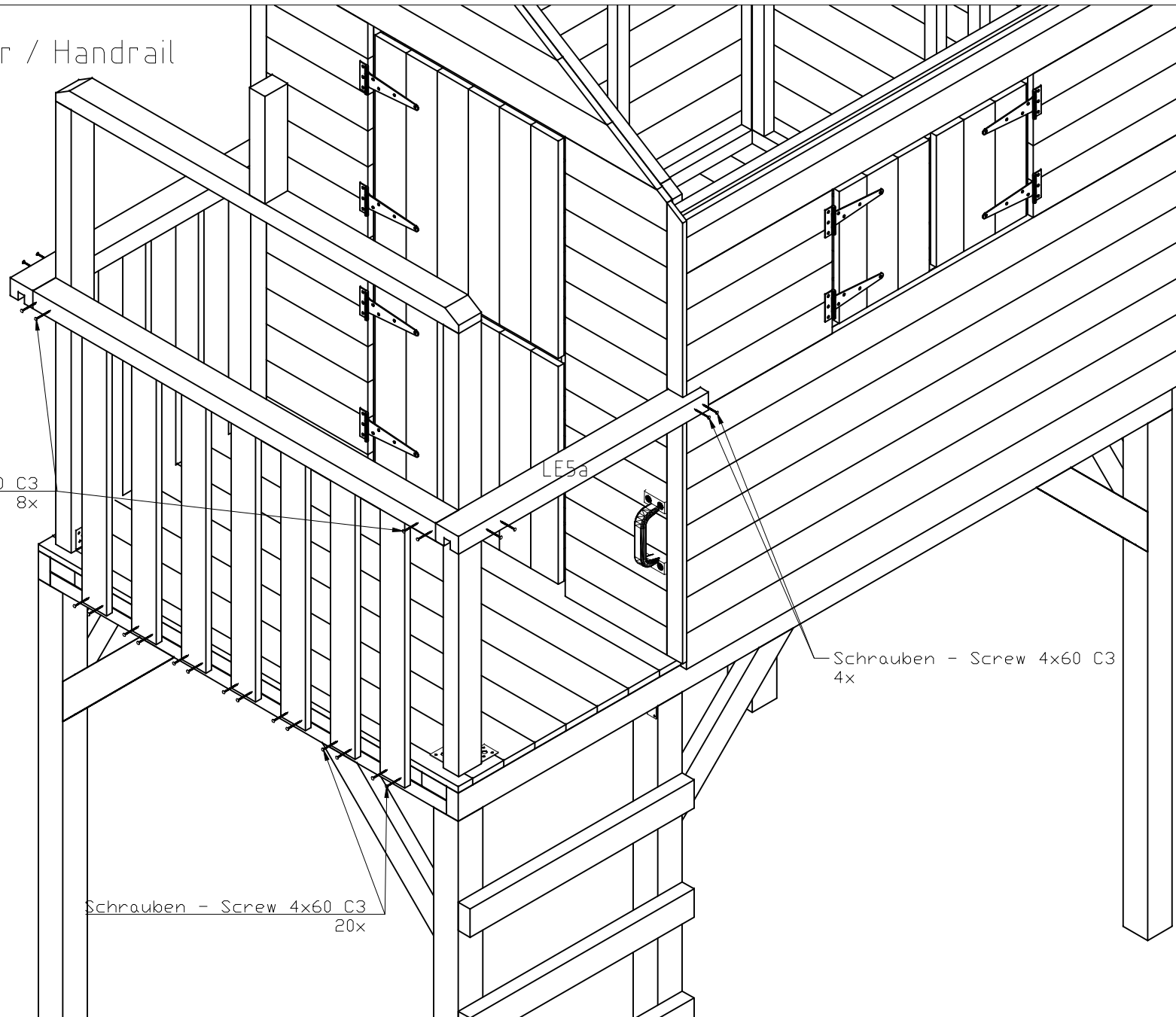

Schrauben - Screw 5x100 C3
8x

LE5a

Schrauben - Screw 4x60 C3
4x

Schrauben - Screw 4x60 C3
20x

Aufbau Anleitung für/Installation guide for "Voldemort 120x204_16"

11.1 Dach / Roof

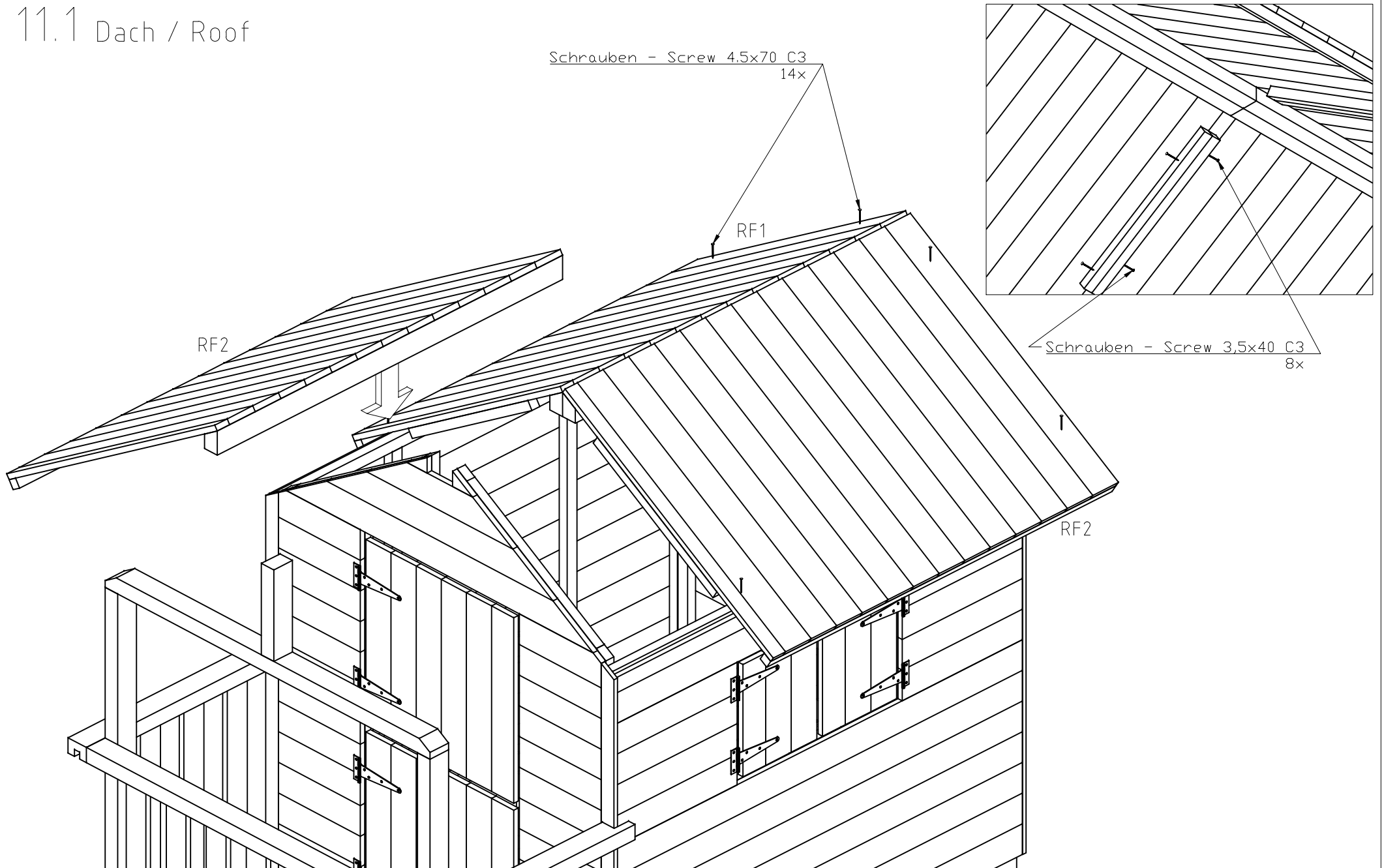

Aufbau Anleitung für/Installation guide for "Voldemort 120x204_16"

11.2 Dach / Roof

Dachpappe - Roofing felt

Dachpappnägel - Roofing nails 2,8x15
36x

Giebelbretter -
Gable boards

Schrauben -
Screw 3,5x40 C3
12x

